

JP065006D3 Specifications

jP^x

3rd Generation 650V/6A SiC Schottky Barrier Diode

1. Basic Information

1.1. General Description

The JP065006D3 SiC Schottky Barrier Diode (SBD) has been developed using JPX's advanced 3rd generation SiC SBD technology with the highest performance and reliability. It registers higher efficiency, higher operation temperature and lower loss and can be operated at higher frequency than Si-based solutions. As to the Schottky structure, it shows no recovery at turn-off and allows a low leakage current with reverse voltage up to 650V. It can contribute to system miniaturization and achieve lightweight system design. Using RoHS compliant components, it is qualified for use in industrial application.

1.2. Features

- Revolutionary semiconductor material - Silicon Carbide (SiC)
- No reverse recovery
- Temperature-independent switching behavior
- High-speed switching performance
- System cost / size savings due to reduced cooling requirements
- Junction temperature range from -55°C to 175°C
- RoHS compliant

1.3. Applications

- Industrial power supplies, Industrial UPS
- Battery chargers
- Solar inverters
- Switch mode power supplies

1.4. Specifications

Device	V _{RRM}	I _F (135°C)	V _F (25°C)	Q _c
JP065006D3	650V	9.9A	1.30V	17nC

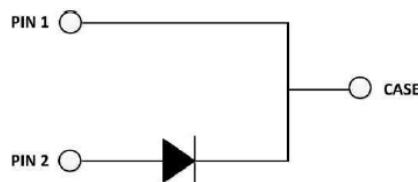

Package Type : TO-252-2L

1.5. Electrical Characteristic Diagrams

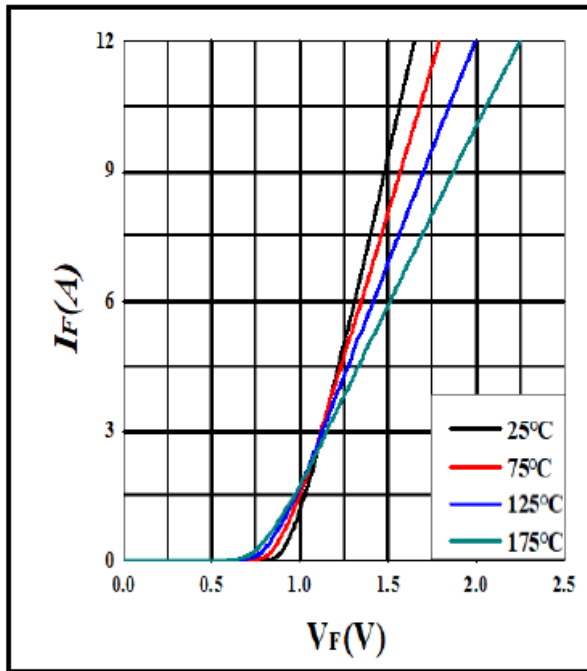

Figure 1. Forward characteristics

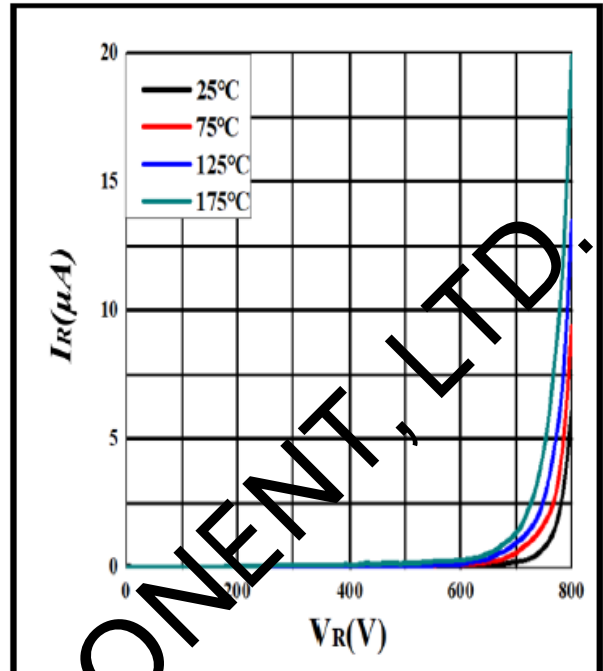

Figure 2. Reverse characteristics

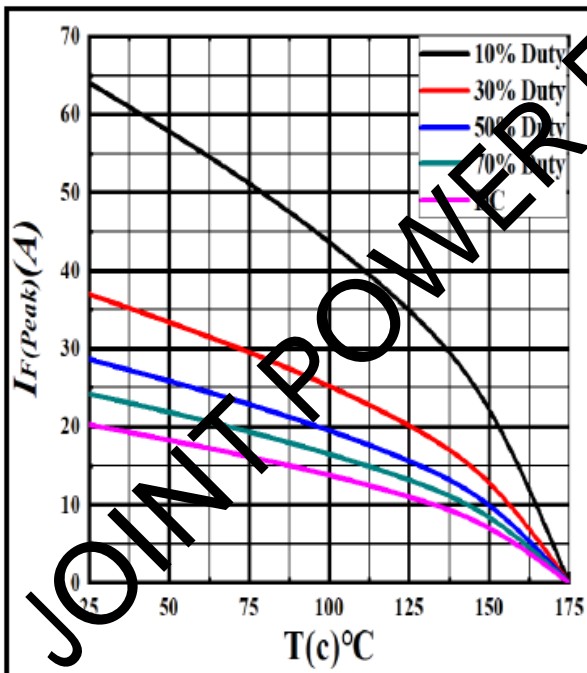

Figure 3. Current derating

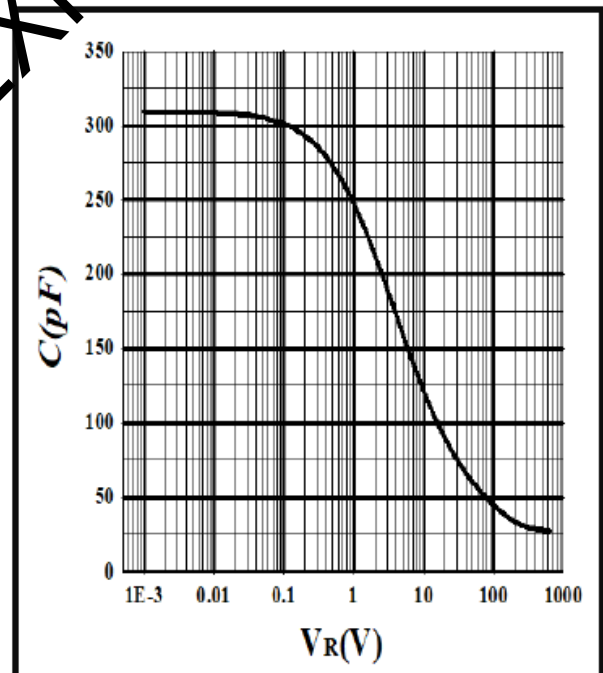

Figure 4. Capacitance vs. reverse voltage

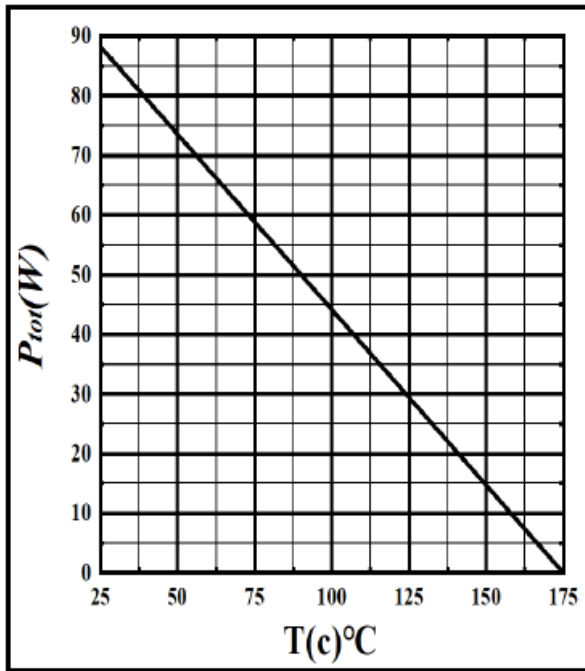

Figure 5. Power derating

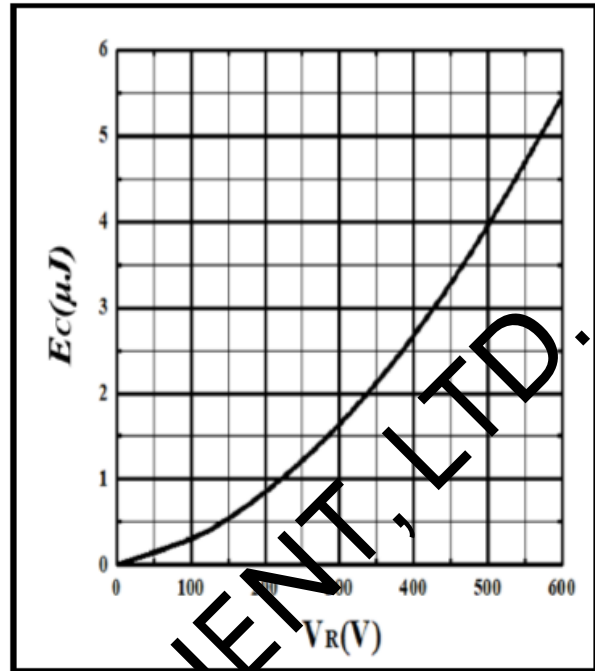

Figure 6. Capacitance stored energy

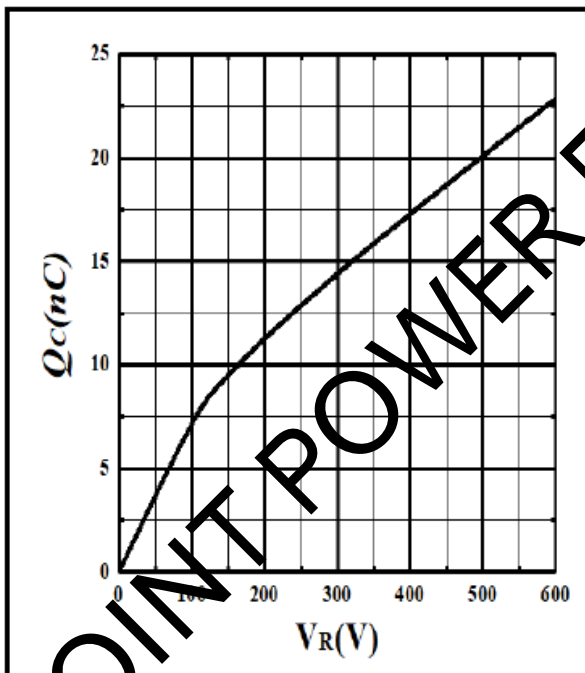

Figure 7. Total capacitance charge vs. reverse voltage

1.6. Absolute Maximum Ratings

(T_c = 25°C, unless otherwise specified)

Parameter	Symbol	Value	Unit	Test conditions
Repetitive peak reverse voltage	V _{RRM}	650	V	T _c = 25°C
Surge peak reverse voltage	V _{RSM}	650	V	T _c = 25°C
DC reverse voltage	V _{DC}	650	V	T _c = 25°C
Continuous forward current	I _F	20	A	T _c = 25°C
		9.9		T _c = 135°C
		6.0		T _c = 155°C
Surge non-repetitive forward current	I _{FSM}	48	A	T _c = 25°C, t _p = 10ms, half sine pulse
Surge repetitive forward current	I _{FRM}	29	A	T _c = 25°C, t _p = 10ms, half sine wave D = 0.1
Power dissipation	P _{tot}	88	W	T _c = 25°C
i ² t value	∫i ² dt	11.5	A ² s	T _c = 25°C, t _p = 10ms
Operating junction temperature	T _j	-55~175	°C	
Storage temperature	T _{stg}	-55~175	°C	

1.7. Thermal Resistance

Symbol	Parameter	Test Conditions	Min.	Typ.	Max.	Unit
R _{th(j-c)}	Thermal resistance from junction to case		/	1.7	/	°C/W

1.8. Static Electrical Characteristics

(T_j = 25°C, unless otherwise specified)

Symbol	Parameter	Test Conditions	Min.	Typ.	Max.	Unit
V _{DC}	DC blocking voltage	I _R = 100 μA	650	/	/	V
V _F	Forward voltage	I _F = 6A, T _j = 25°C	/	1.30	1.50	V
		I _F = 6A, T _j = 175°C	/	1.55	1.80	
I _R	Reverse current	V _R = 650V, T _j = 25°C	/	1	20	μA
		V _R = 650V, T _j = 175°C	/	5	50	

1.9. Dynamic Electrical Characteristics

(T_j = 25°C, unless otherwise specified)

Symbol	Parameter	Test Conditions	Min.	Typ.	Max.	Unit
C	Total capacitance	V _R = 0V, f = 1MHz	/	310	/	pF
		V _R = 200V, f = 1MHz	/	33	/	
		V _R = 400V, f = 1MHz	/	28	/	
Q _c	Total capacitive charge	V _R = 400V	/	17	/	nC
E _c	Capacitance stored energy	V _R = 400V	/	2.6	/	μJ

2. Package Information

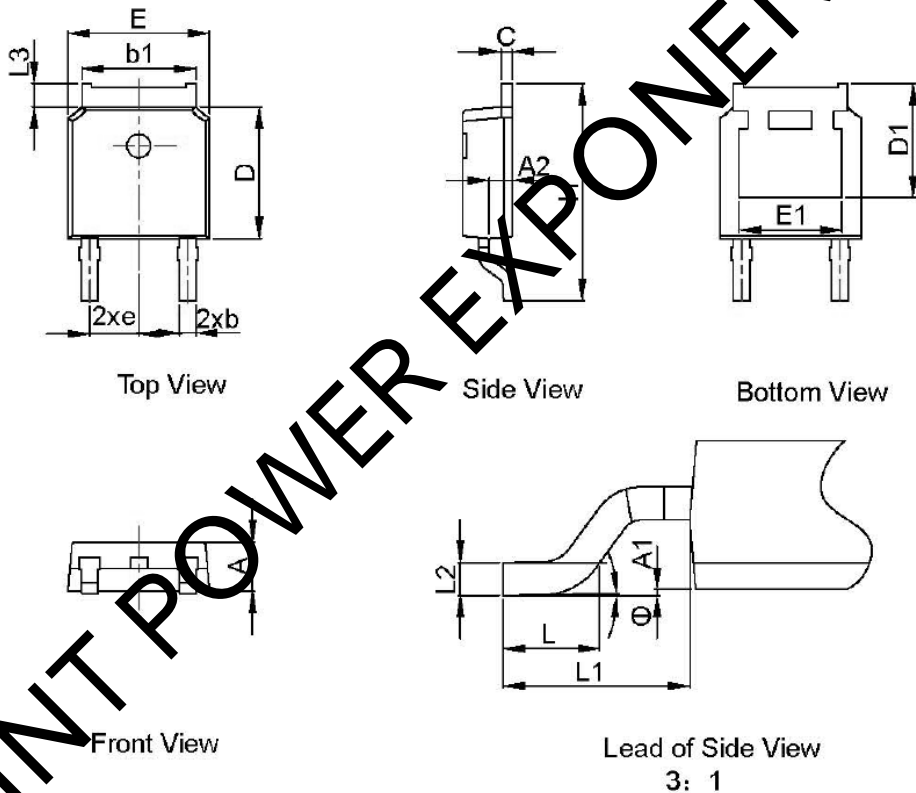

Dimension unit: [mm]			
Symbol	Min	Nom	Max
A	2.20	2.30	2.38
A1	0	-	0.127
A2	0.97	1.07	1.17
b	0.68	0.78	0.90
b1	5.20	5.33	5.46
c	0.43	0.53	0.61
D	5.98	6.10	6.22
D1	5.30 REF		
E	6.40	6.60	6.73
E1	4.63	-	-
e	2.286 BSC		
H	9.40	10.10	10.50
L	1.38	1.50	1.75
L1	2.743 REF		
L2	0.51 BSC		
L3	0.88	-	1.27
L4	0.50	-	1.00
θ	0°	-	8°

3. Recommended Solder Pad Layout

All dimensions are in mm.

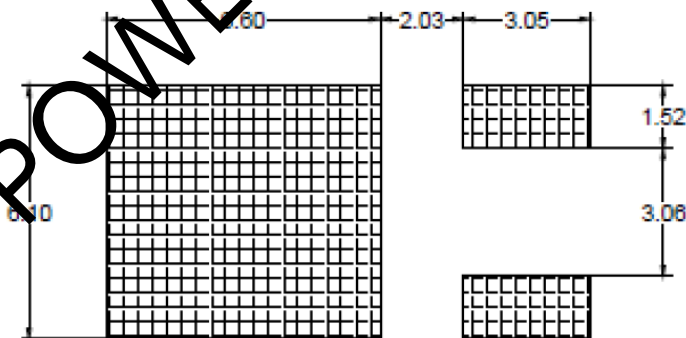

4. Ordering Information

Part Number	JP065006D3
Package	TO-252-2L
Unit Quantity	2500 EA
Packing Type	Tape & Reel

Contact info e-mail : contact@jpx.com.tw